

**Jeronimo
& Morais**

FERRAMENTAS • PEDRA • AUTO

Top Line

THE ONE



 Alla fine degli anni '70 **Manzelli**, realtà stimata nel settore delle forniture industriali per il marmo già dagli anni '50, diede inizio alla produzione delle prime ventose per il sollevamento ad aria compressa.

Oggi, grazie all'esperienza acquisita e interpretando le esigenze dei clienti, **Manzelli** è riconosciuta come azienda leader nella progettazione di apparecchiature per il sollevamento. Il brand **Manzelli** viene infatti apprezzato sui mercati internazionali per il suo inconfondibile *Made in Italy* e per l'accattivante *design*, che lo rendono il più apprezzato dagli operatori di settore.

L'offerta di apparecchiature **Manzelli** abbraccia i più svariati settori: marmo, vetro, metallo, lamiera, legno e packaging.

Negli ultimi anni di crescita aziendale, grazie alla maggiore presenza sui mercati internazionali e stimolati ad arricchire la nostra offerta, **Liftstyle** ha introdotto due nuove linee di prodotto:

Atmosphere - Air purification systems

Terra - Water purification systems

La nostra filosofia aziendale stimola la ricerca a elevare la qualità del prodotto, rafforzando la nostra *mission* nel perseguire valide soluzioni tecniche, rivolte alla sicurezza delle persone che ci scelgono come loro partner.

 Esteemed reality in the marble industry from the '50, **Manzelli** started the production of air powered vacuum lifters at the end of the '70.

Thanks to the long experience and the requests received from key clients through the years, **Manzelli** is a recognized leading brand in the manufacture of lifting equipment. The brand is appreciated worldwide for its unique *Made in Italy* style and its attractive *design*, which make the **Manzellis** the most appreciated lifters in the stone sector.

The product range includes many industries: stone, glass, metal, wood and packaging.

During the years, **Liftstyle** has become even more competitive on the international markets. This credit encouraged us to increase our offer; therefore we introduced two new product lines:

Atmosphere - Air purification systems

Terra - Water purification systems

Our corporate philosophy drives us to constant research for the improvement of our quality, and it fortifies our *mission* of enhancing our technical solutions, aimed at the safety of those who choose Liftstyle as their partner.

**QUALITY, SAFETY, PERFORMANCE:
MINIMUM EFFORT FOR MAXIMUM RESULTS**

Our Top Line lifters for your Top Line production.

The best raw materials for a long lasting machine.

A meticulous manufacture for the finishing touch.

- Funzionante ad aria compressa con eiettore in alluminio e silenziatore
- Pressione d'esercizio per creazione vuoto 3,5 bar
- Pressione d'esercizio per ribaltamento pneumatico 6 bar
- Consumo d'aria 95 l/min
- Portata uguale in posizione orizzontale e verticale
- Struttura in acciaio saldata con certificazione EN ISO 9606 - 1:2013
- Piastre e contropiastre in acciaio inox
- Supporti piastra con attacco rapido
- Attacco e stacco delle piastre per mezzo di valvola a corsoio in alluminio anodizzato con blocco in posizione di presa
- Vuotometro in acciaio inox e in bagno di glicerina; la scala colorata facilita il controllo del grado di vuoto in posizione di presa
- Serbatoio di riserva vuoto in alluminio
- **Ribaltamento manuale o pneumatico da 0° a 90°**
- Allarme acustico e luminoso autonomo, con pannelli solari e completo di caricabatteria (lampeggia e suona se il grado di vuoto non è sufficiente per il sollevamento)
- *Powered by compressed air with aluminium ejector and silencer*
- *Operating pressure for vacuum creation 3.5 bar*
- *Operating pressure for pneumatic tilt 6 bar*
- *Air consumption 95 l/min*
- *Same capacity in horizontal and vertical position*
- *Steel structure, welded and certified EN ISO 9606 - 1:2013*
- *Suction plates and backing plates made of stainless steel*
- *Supports with rapid attack*
- *Connection and disconnection of the plates by means of slider valve made of anodized aluminium; it locks when in connect mode*
- *Vacuum gauge made of stainless steel and dipped in glycerine; the coloured scale facilitates the control of the vacuum level when in connect mode*
- *Vacuum reserve tank made of aluminium*
- ***Manual or pneumatic tilt from 0° to 90°***
- *Self-governing luminous/acoustic alarm system with solar panels and complete with battery charger (it flashes and rings if the vacuum level is not sufficient for the lifting process)*



Top Line

THE ONE

VAM 1

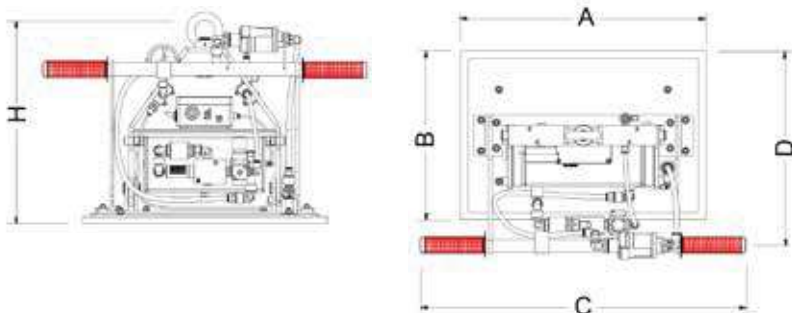

MODELLO MODEL	PORTATA (KG) CAPACITY	PIASTRE PLATES	A mm	B mm	C mm	D mm	H mm
VAM 1/125	125	1	450	200	630	330	400
VAM 1/125	125	1	550	150	450	340	570
VAM 1/200	200	1	600	200	630	330	400
VAM 1/200	200	1	700	160	740	310	420
VAM 1/250	250	1	600	250	630	355	400
VAM 1/250	250	1	450	300	630	380	400
VAM 1/300	300	1	600	300	630	380	400
VAM 1/300	300	1	800	200	740	330	420
VAM 1/500	500	1	600	400	740	430	420
VAM 1/500	500	1	800	300	740	380	420
VAM 1/800	800	1	900	450	510	530	600
VAM 1/1000	1000	1	900	500	510	555	600

Portata da 125 a 1000 Kg / Ribaltamento MANUALE da 0° a 90°
Capacity from 125 to 1000 Kg / MANUAL tilt from 0° to 90°

from 125 to 800 kg

1000 kg

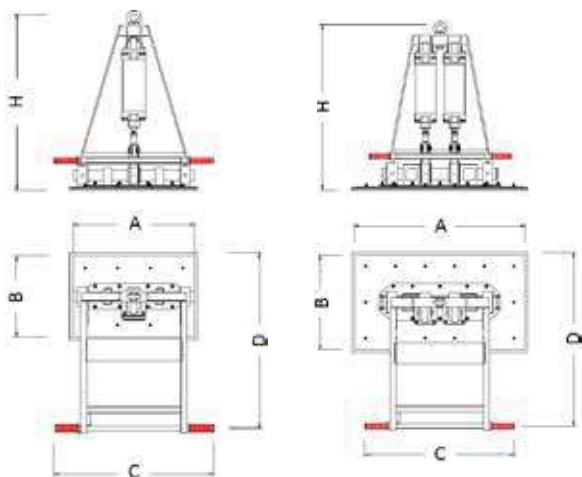

VAM 1PN

MODELLO MODEL	PORTATA (KG) CAPACITY	PIASTRE PLATES	A mm	B mm	C mm	D mm	H mm
VAM 1PN/125	125	1	450	200	780	765	865
VAM 1PN/125	125	1	550	150	780	720	865
VAM 1PN/200	200	1	600	200	780	765	865
VAM 1PN/200	200	1	700	160	780	735	880
VAM 1PN/250	250	1	450	300	780	815	865
VAM 1PN/250	250	1	600	250	780	790	865
VAM 1PN/300	300	1	600	300	780	815	865
VAM 1PN/300	300	1	800	200	780	765	880
VAM 1PN/500	500	1	600	400	780	865	865
VAM 1PN/500	500	1	800	300	780	815	865
VAM 1PN/800	800	1	900	450	780	895	865
VAM 1PN/1000	1000	1	900	500	780	920	885

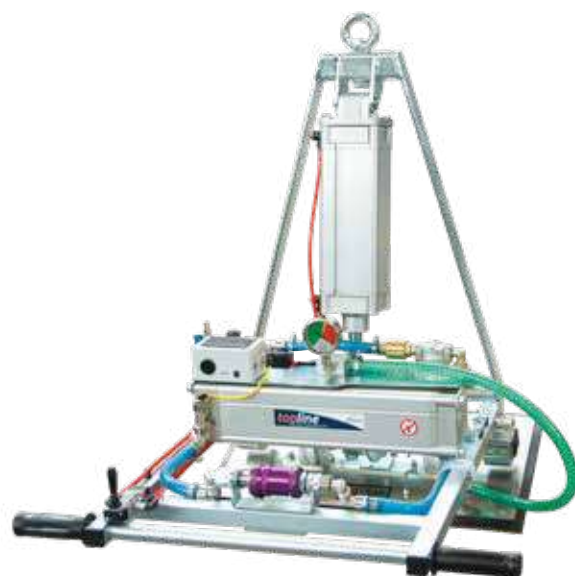

Portata da 125 a 1000 Kg / Ribaltamento PNEUMATICO da 0° a 90°

Capacity from 125 to 1000 Kg / PNEUMATIC tilt from 0° to 90°

VAM 1P

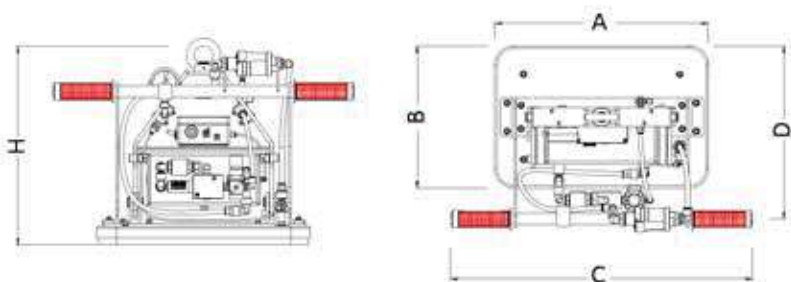

MODELLO MODEL	PORTATA (KG) CAPACITY	PIASTRE PLATES	A mm	B mm	C mm	D mm	H mm
VAM 1P/125	125	1	450	200	630	315	405
VAM 1P/125	125	1	550	150	450	335	570
VAM 1P/200	200	1	600	200	630	315	405
VAM 1P/200	200	1	700	160	730	295	405
VAM 1P/250	250	1	600	250	630	340	405
VAM 1P/250	250	1	450	300	630	365	405
VAM 1P/300	300	1	600	300	630	365	405
VAM 1P/300	300	1	800	200	730	315	405
VAM 1P/500	500	1	600	400	730	415	405
VAM 1P/500	500	1	800	300	730	365	405
VAM 1P/800	800	1	900	450	510	514	610
VAM 1P/1000	1000	1	900	500	510	540	610

Piastra in ALLUMINIO per superfici irregolari

Portata da 125 a 1000 Kg / Ribaltamento MANUALE da 0° a 90°

ALUMINIUM suction plate for irregular surfaces

Capacity from 125 to 1000 Kg / MANUAL tilt from 0° to 90°

VAM 1IS

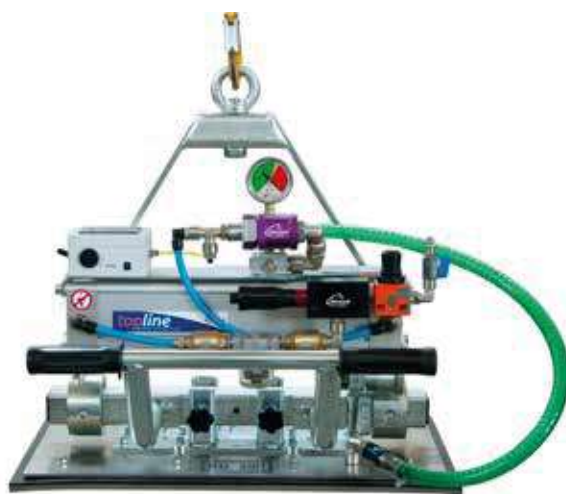
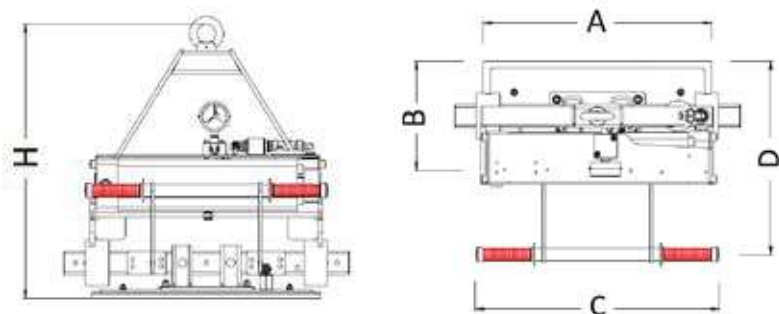

MODELLO MODEL	PORTATA (KG) CAPACITY	PIASTRE PLATES	A mm	B mm	C mm	D mm	H mm
VAM 1/125 IS	125	1	450	200	510	405	575
VAM 1/125 IS	125	1	550	150	510	370	575
VAM 1/200 IS	200	1	600	200	510	405	575
VAM 1/200 IS	200	1	700	160	510	385	593
VAM 1/250 IS	250	1	600	250	510	430	575
VAM 1/250 IS	250	1	450	300	510	455	575
VAM 1/300 IS	300	1	600	300	510	455	575
VAM 1/300 IS	300	1	800	200	510	405	575
VAM 1/500 IS	500	1	600	400	510	505	575
VAM 1/500 IS	500	1	800	300	510	455	575
VAM 1/800 IS	800	1	900	450	510	530	580
VAM 1/1000 IS	1000	1	900	500	510	555	580

Piastra intercambiabile

Portata da 125 a 1000 Kg / Ribaltamento MANUALE da 0° a 90°

Interchangeable plate

Capacity from 125 to 1000 Kg / MANUAL tilt from 0° to 90°

VAM 1P SIMPATICA

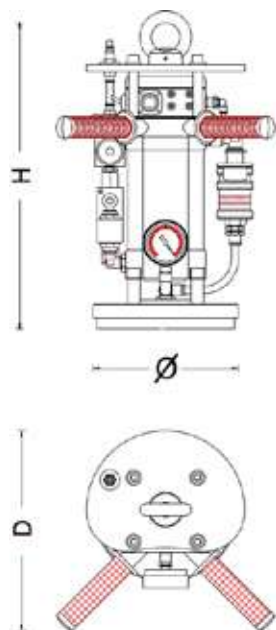

Struttura compatta con piastra in ALLUMINIO

Portata da 40 a 70 Kg / Fissa in orizzontale

Compact structure with ALUMINIUM plate

Capacity from 40 to 70 Kg / Fixed in horizontal

MODELLO MODEL	PORTATA (KG) CAPACITY	PIASTRE PLATES	D mm	H mm	Ø mm
VAM 1P SIMPATICA/40	40	1	280	370	160
VAM 1P SIMPATICA/70	70	1	280	370	200

VAM 2

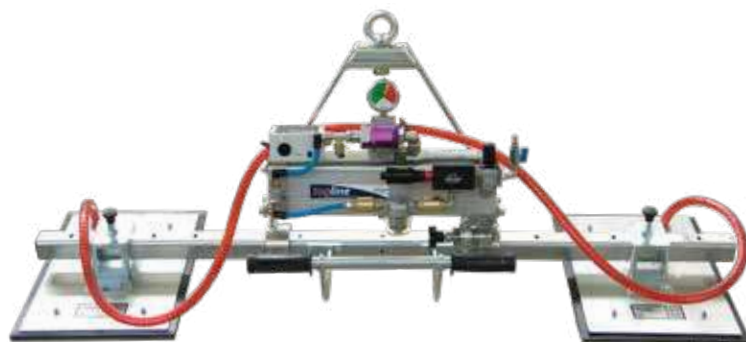
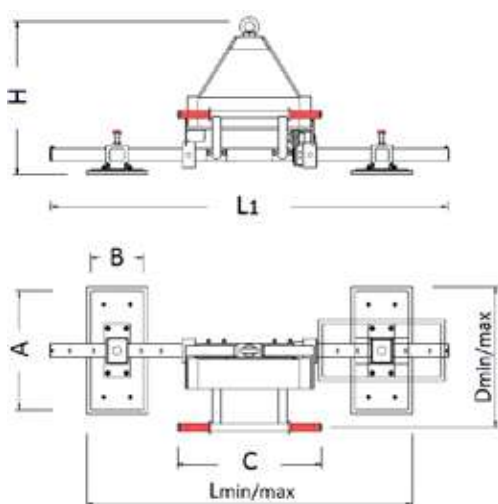

Portata da 250 a 1000 Kg / Ribaltamento MANUALE da 0° a 90°

Capacity from 250 to 1000 Kg / MANUAL tilt from 0° to 90°

MODELLO MODEL	PORTATA (KG) CAPACITY	PIASTRE PLATES	A mm	B mm	C mm	D min mm	D max mm	L1 mm	L min mm	L max mm	H mm
VAM 2/250	250	2	450	200	510	405	530	1500	900	1840	575
VAM 2/500	500	2	450	300	510	455	530	1500	1000	1840	575
VAM 2/1000	1000	2	600	400	510	510	610	1500	1140	2005	680

VAM 2PN

from 250 to 500 kg

from 1000 to 1400 kg

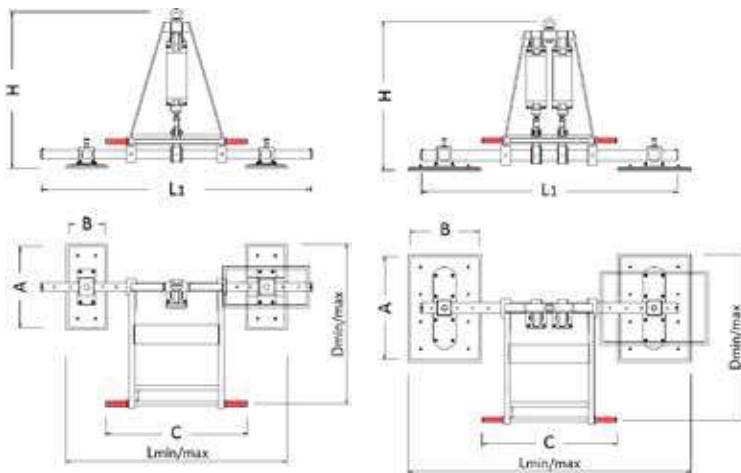

Portata da 250 a 1400 Kg / Ribaltamento PNEUMATICO da 0° a 90°
Capacity from 250 to 1400 Kg / PNEUMATIC tilt from 0° to 90°

MODELLO MODEL	PORTATA (KG) CAPACITY	PIASTRE PLATES	A mm	B mm	C mm	D min mm	D max mm	L1 mm	L min mm	L max mm	H mm
VAM 2PN/250	250	2	450	200	780	765	890	1500	900	1840	865
VAM 2PN/500	500	2	450	300	780	815	890	1500	1000	1840	865
VAM 2PN/1000	1000	2	600	400	780	870	970	1500	1140	2005	870
VAM 2PN/1400	1400	2	800	400	780	895	1095	1500	1140	2205	1045

VAM 2PN LOW

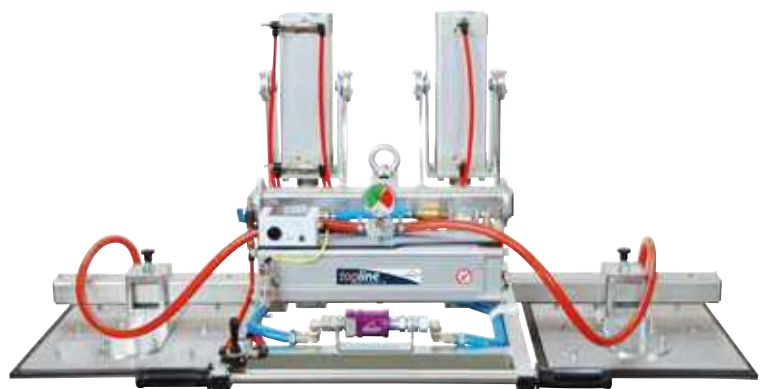
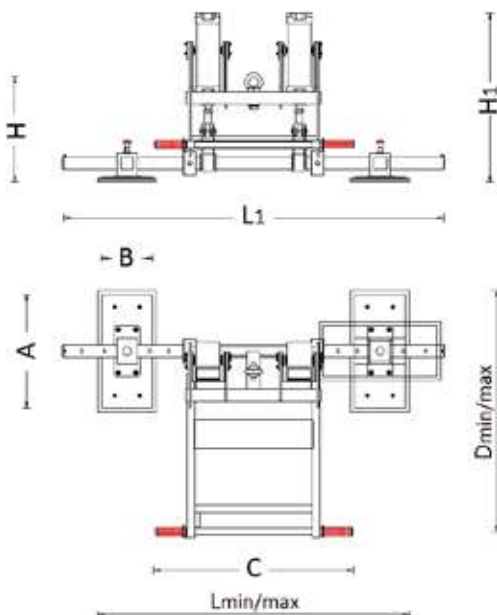

Versione RIBASSATA

Portata da 250 a 1000 Kg / Ribaltamento PNEUMATICO da 0° a 90°
LOW version
Capacity from 250 to 1000 Kg / PNEUMATIC tilt from 0° to 90°

MODELLO MODEL	PORTATA (KG) CAPACITY	PIASTRE PLATES	A mm	B mm	C mm	D min mm	D max mm	L1 mm	L min mm	L max mm	H mm	H1 mm
VAM 2PN/250 LOW	250	2	450	200	780	830	955	1500	900	1840	415	670
VAM 2PN/500 LOW	500	2	450	300	780	880	955	1500	1000	1840	415	670
VAM 2PN/1000 LOW	1000	2	600	400	780	965	1065	1500	1140	2005	420	715

VAM 3

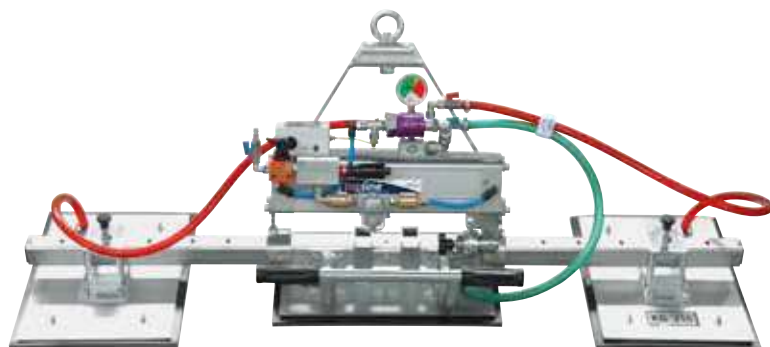
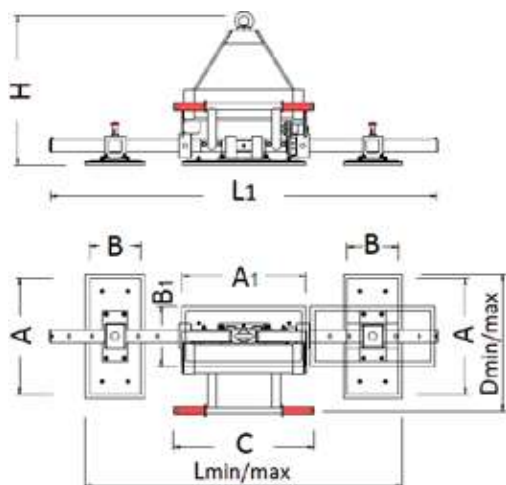

Portata da 375 a 1500 Kg / Ribaltamento MANUALE da 0° a 90°
Capacity from 375 to 1500 Kg / MANUAL tilt from 0° to 90°

MODELLO MODEL	PORTATA (KG) CAPACITY	PIASTRE PLATES	A mm	B mm	A1 mm	B1 mm	C mm	D min mm	D max mm	L1 mm	L min mm	L max mm	H mm
VAM 3/375	375	3	450	200	450	200	510	405	530	1500	1050	1840	575
VAM 3/625	625	3	450	300	450	200	510	455	530	1500	1150	1840	575
VAM 3/750	750	3	450	300	450	300	510	455	530	1500	1150	1840	575
VAM 3/1250	1250	3	600	400	600	250	510	510	610	1500	1510	2005	690
VAM 3/1500	1500	3	600	400	600	400	510	510	610	1500	1510	2005	690

from 375 to 625 kg

from 1000 to 1500 kg

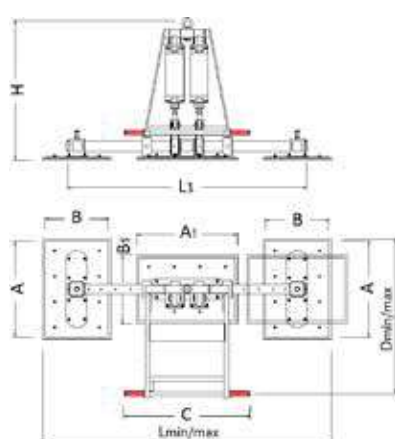
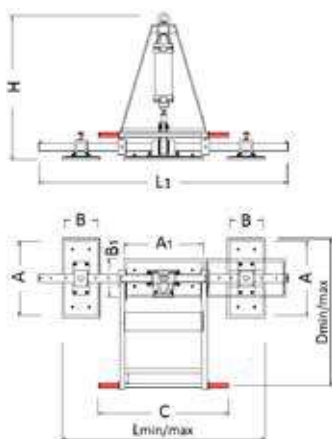

VAM 3PN

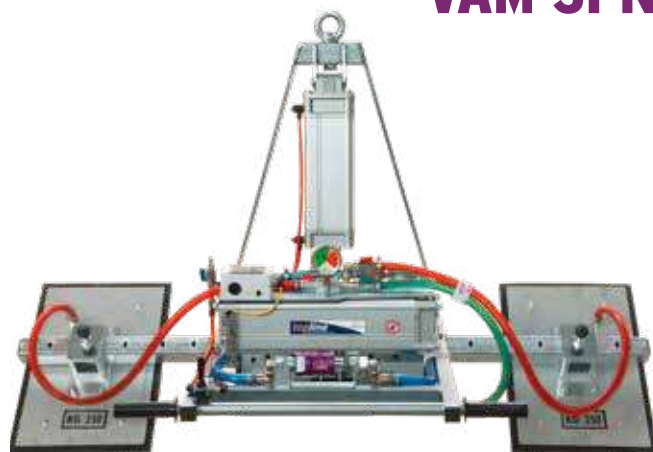

Portata da 375 a 1500 Kg / Ribaltamento PNEUMATICO da 0° a 90°
Capacity from 375 to 1500 Kg / PNEUMATIC tilt from 0° to 90°

MODELLO MODEL	PORTATA (KG) CAPACITY	PIASTRE PLATES	A mm	B mm	C mm	D1 mm	D mm	D min mm	D max mm	L1 mm	L min mm	L max mm	H mm
VAM 3PN/375	375	3	450	200	450	200	780	765	890	1500	1050	1840	865
VAM 3PN/625	625	3	450	300	450	200	780	815	890	1500	1150	1840	865
VAM 3PN/1000	1000	3	600	400	600	250	780	870	970	1500	1510	2005	870
VAM 3PN/1250	1250	3	600	400	600	250	780	895	995	1500	1510	2005	1045
VAM 3PN/1500	1500	3	600	400	600	400	780	895	995	1500	1510	2005	1045

VAM 3PN LOW

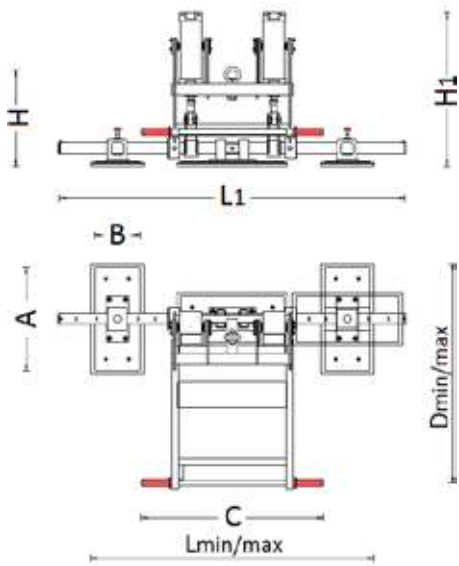

Versione RIBASSATA

Portata da 375 a 1000 Kg / Ribaltamento PNEUMATICO da 0° a 90°

LOW version

Capacity from 375 to 1000 Kg / PNEUMATIC tilt from 0° to 90°

MODELLO MODEL	PORTATA (KG) CAPACITY	PIASTRE PLATES	A mm	B mm	A1 mm	B1 mm	C mm	D min mm	D max mm	L1 mm	L min mm	L max mm	H mm	H1 mm
VAM 3PN/375 LOW	375	3	450	200	450	200	780	830	955	1500	1050	1840	415	670
VAM 3PN/625 LOW	625	3	450	300	450	200	780	880	955	1500	1150	1840	415	670
VAM 3PN/750 LOW	750	3	450	300	450	300	780	915	990	1500	1230	1855	420	715
VAM 3PN/1000 LOW	1000	3	600	400	600	250	780	965	1065	1500	1510	2005	420	715

VAM 4

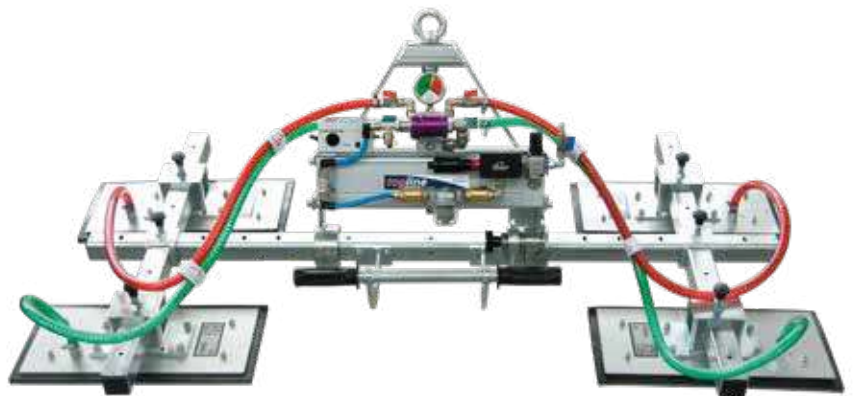
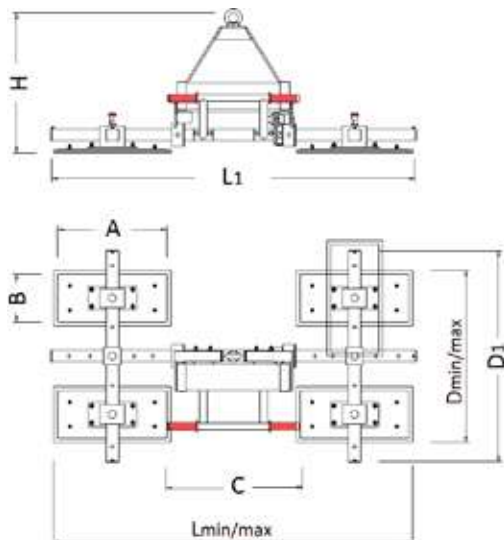

Portata da 500 a 2000 Kg / Ribaltamento MANUALE da 0° a 90°

Capacity from 500 to 2000 Kg / MANUAL tilt from 0° to 90°

MODELLO MODEL	PORTATA (KG) CAPACITY	PIASTRE PLATES	A mm	B mm	C mm	D1 mm	D min mm	D max mm	L1 mm	L min mm	L max mm	H mm
VAM 4/500	500	4	450	200	510	870	470	1230	1500	900	1840	575
VAM 4/1000	1000	4	450	300	510	880	670	1240	1500	1040	1855	670
VAM 4/1500	1500	4	600	300	510	880	670	1390	1500	1040	2005	680
VAM 4/2000	2000	4	600	400	510	810	870	1320	1500	1200	2020	760

VAM 4PN

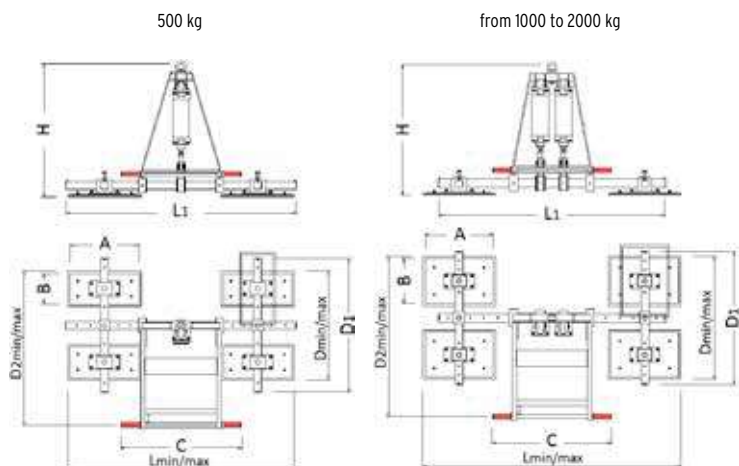

Portata da 500 a 2000 Kg / Ribaltamento PNEUMATICO da 0° a 90°
Capacity from 500 to 2000 Kg / PNEUMATIC tilt from 0° to 90°

MODELLO MODEL	PORTATA (KG) CAPACITY	PIASTRE PLATES	A mm	B mm	C mm	D1 mm	D min mm	D max mm	D2 min mm	D2 max mm	L min mm	L max (L1=1500) mm	L max (L1=2400) mm	H mm
VAM 4PN/500 L1=1500/2400	500	4	450	200	780	870	470	1230	885	1265	900	1840	2310	866
VAM 4PN/500 KTV L1= 2400	500	4	550	150	780	870	400	1310	830	1305	830	-	2390	865
VAM 4PN/1000 L1=1500/2400	1000	4	450	300	780	880	670	1240	990	1275	1110	1855	2220	860
VAM 4PN/1500	1500	4	600	300	780	880	670	1390	1015	1375	1040	2005	-	1030
VAM 4PN/2000	2000	4	600	400	780	810	870	1320	1195	1420	1230	2050	-	1270

VAM 4PN LOW

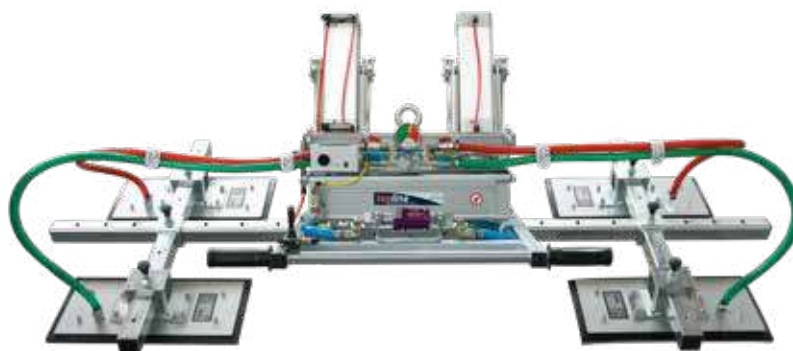
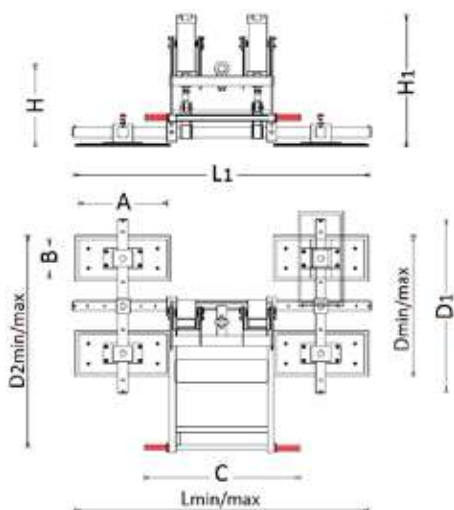

Versione RIBASSATA

Portata da 500 a 1000 Kg / Ribaltamento PNEUMATICO da 0° a 90°

LOW version

Portata da 500 a 1000 Kg / PNEUMATIC tilt from 0° to 90°

MODELLO MODEL	PORTATA (KG) CAPACITY	PIASTRE PLATES	A mm	B mm	C mm	D1 mm	D min mm	D max mm	D2 min mm	D2 max mm	L min mm	L max (L1=1500) mm	L max (L1=2400) mm	H mm	H1 mm
VAM 4/PN500 LOW L1=1500/2400	500	4	450	200	780	870	470	1230	950	1330	900	1840	2310	415	670
VAM 4PN/500 KTV LOW L1=2400	500	4	550	150	780	870	400	1310	915	1370	830	-	2390	415	670
VAM 4/PN1000 LOW L1=1500/2400	1000	4	450	300	780	880	670	1240	1085	1370	1110	1855	2220	420	715

VAM 4PN KTL

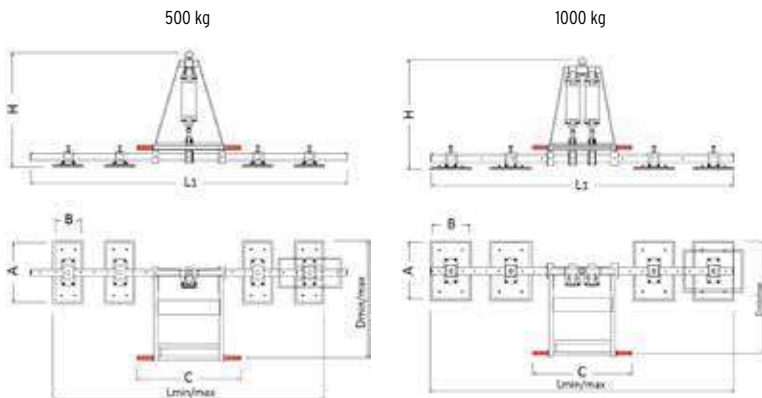

Piani cucina IN LINEA

Portata da 500 a 1000 Kg / Ribaltamento PNEUMATICO da 0° a 90°

Kitchen top IN LINE

Capacity from 500 to 1000 Kg / PNEUMATIC tilt from 0° to 90°

MODELLO MODEL	PORTATA (KG) CAPACITY	PIASTRE PLATES	A mm	B mm	C mm	D min mm	D max mm	L1 mm	L min mm	L max mm	H mm
VAM 4PN/500 KTL	500	4	450	200	780	765	890	2400	1475	2740	865
VAM 4PN/500 KTL	500	4	550	150	780	740	930	2400	1205	2820	865
VAM 4PN/1000 KTL	1000	4	450	300	780	820	895	2400	1850	2755	870

VAM 4PN KTL LOW

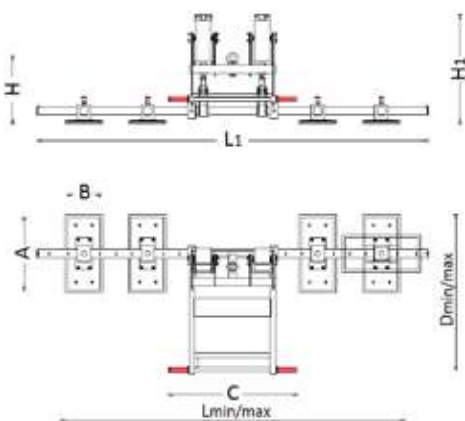

Piani cucina IN LINEA / Versione RIBASSATA

Portata da 500 a 1000 Kg / Ribaltamento PNEUMATICO da 0° a 90°

Kitchen top IN LINE / LOW version

Capacity from 500 to 1000 Kg / PNEUMATIC tilt from 0° to 90°

MODELLO MODEL	PORTATA (KG) CAPACITY	PIASTRE PLATES	A mm	B mm	C mm	D min mm	D max mm	L1 mm	L min mm	L max mm	H mm	H1 mm
VAM 4PN/500 KTL LOW	500	4	450	200	780	830	955	2400	1475	2740	415	670
VAM 4PN/500 KTL LOW	500	4	550	150	780	805	995	2400	1205	2820	415	670
VAM 4PN/1000 KTL LOW	1000	4	450	300	780	915	990	2400	1850	2755	420	715

VAM 5

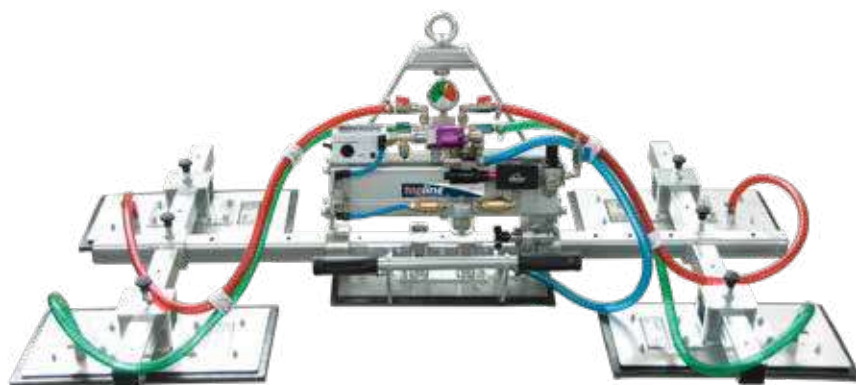
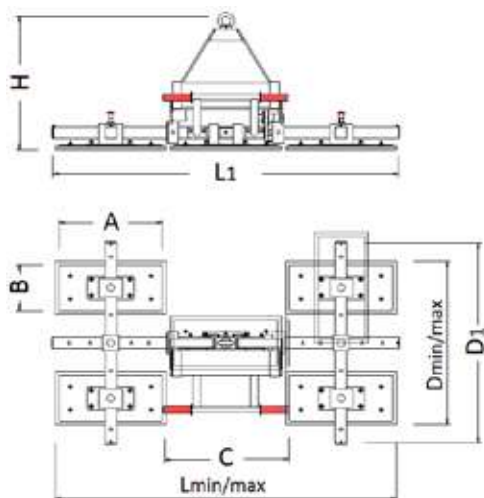

Portata da 625 a 1500 Kg / Ribaltamento MANUALE da 0° a 90°
Capacity from 625 to 1500 Kg / MANUAL tilt from 0° to 90°

MODELLO MODEL	PORTATA (KG) CAPACITY	PIASTRE PLATES	A mm	B mm	C mm	D1 mm	D min mm	D max mm	L1 mm	L min mm	L max mm	H mm
VAM 5/625	625	5	450	200	510	870	470	1230	1500	900**	1840	575
VAM 5/1000	1000	5	450	300	510	880	670	1240	1500	1190*	1855	680
VAM 5/1500	1500	5	600	300	510	880	670	1390	1500	1340*	2005	690

* PIASTRE ORIZZONTALI -> ESTENSIONE MAX SU SBRACCI / HORIZONTAL PLATES -> MAX EXTENSION ON THE ARMS

** PIASTRE VERTICALI -> ESTENSIONE MAX SU SBRACCI / VERTICAL PLATES -> MAX EXTENSION ON THE ARMS

VAM 5PN

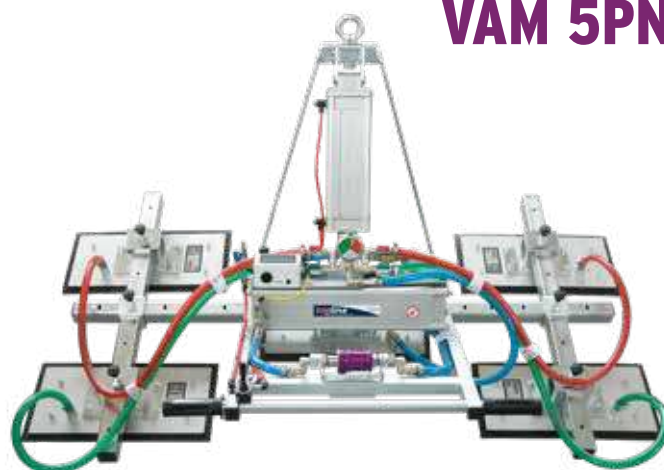
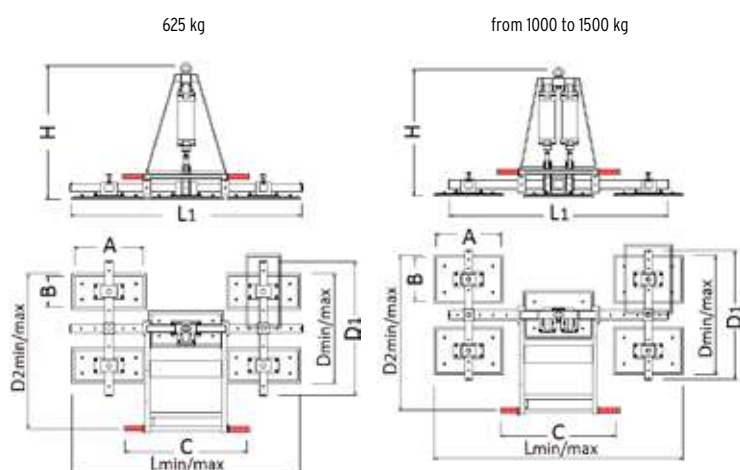

Portata da 625 a 1500 Kg / Ribaltamento PNEUMATICO da 0° a 90°
Capacity from 625 to 1500 Kg / PNEUMATIC tilt from 0° to 90°

MODELLO MODEL	PORTATA (KG) CAPACITY	PIASTRE PLATES	A mm	B mm	C mm	D1 mm	D min mm	D max mm	D2 min mm	D2 max mm	L min mm	L max (L1=1500) mm	L max (L1=2400) mm	H mm
VAM 5PN/625 L1=1500/2400	625	5	450	200	780	870	470	1230	885	1265	900**	1840	2310	865
VAM 5PN/625 KTV L1=2400	625	5	550	150	780	870	400	1310	850	1305	830	-	2390	865
VAM 5PN/1000 L1=1500/2400	1000	5	450	300	780	880	670	1240	990	1275	1260*	1855	2220	870
VAM 5PN/1500	1500	5	600	300	780	880	670	1400	1015	1380	1340*	2005	-	1040

* PIASTRE ORIZZONTALI -> ESTENSIONE MAX SU SBRACCI / HORIZONTAL PLATES -> MAX EXTENSION ON THE ARMS

** PIASTRE VERTICALI -> ESTENSIONE MAX SU SBRACCI / VERTICAL PLATES -> MAX EXTENSION ON THE ARMS

VAM 5PN KTV LOW

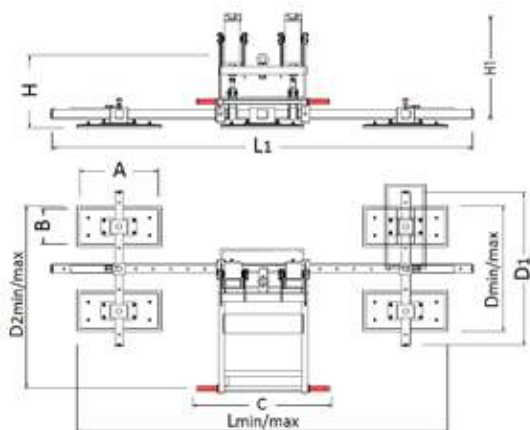

Piani cucina **VERSATILE** / Versione **RIBASSATA**

Portata da 625 a 1000 Kg / Ribaltamento PNEUMATICO da 0° a 90°

*Kitchen top **VERSATILE** / **LOW** version*

Capacity from 625 to 1000 Kg / PNEUMATIC tilt from 0° to 90°

MODELLO MODEL	PORTATA (KG) CAPACITY	PIASTRE PLATES	A mm	B mm	C mm	D1 mm	D min mm	D max mm	D2 min mm	D2 max mm	L1 mm	L min mm	L max mm	H mm	H1 mm
VAM 5PN/625 KTV LOW	625	5	450	200	780	870	470	1230	950	1330	2400	900**	2310	412	670
VAM 5PN/625 KTV LOW	625	5	550	150	780	870	400	1310	915	1370	2400	830	2390	412	670
VAM 5PN/1000 KTV LOW	1000	5	450	300	780	880	670	1240	1085	1370	2400	1260*	2220	420	715

* PIASTRE ORIZZONTALI -> ESTENSIONE MAX SU SBRACCI / HORIZONTAL PLATES -> MAX EXTENSION ON THE ARMS

** PIASTRE VERTICALI -> ESTENSIONE MAX SU SBRACCI / VERTICAL PLATES -> MAX EXTENSION ON THE ARMS

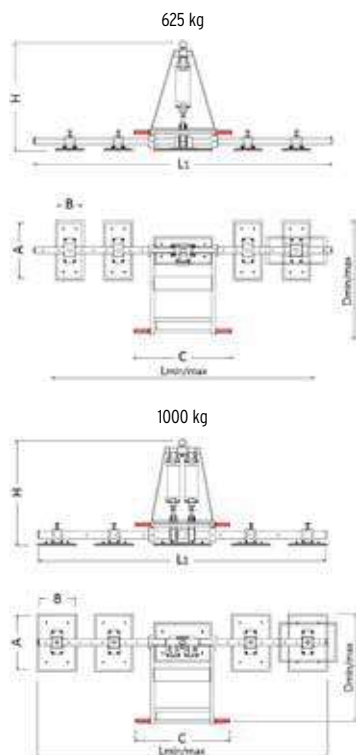

VAM 5PN KTL



Piani cucina **IN LINEA**

Portata da 625 a 1000 Kg / Ribaltamento PNEUMATICO da 0° a 90°

*Kitchen top **IN LINE***

Capacity from 625 to 1000 Kg / PNEUMATIC tilt from 0° to 90°

MODELLO MODEL	PORTATA (KG) CAPACITY	PIASTRE PLATES	A mm	B mm	C mm	D min mm	D max mm	L1 mm	L min mm	L max mm	H mm
VAM 5PN/625 KTL	625	5	450	200	780	765	890	2400	1670	2740	865
VAM 5PN/625 KTL	625	5	550	150	780	740	930	2400	1402	2820	865
VAM 5PN/1000 KTL	1000	5	450	300	780	820	895	2400	2040	2755	870

VAM 5 PN KTL LOW

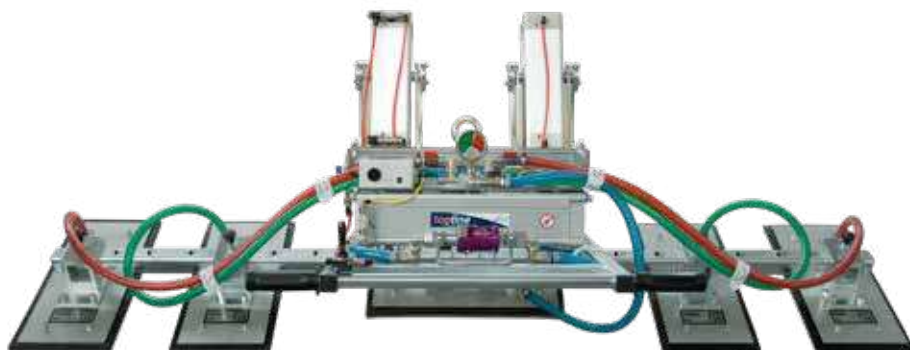
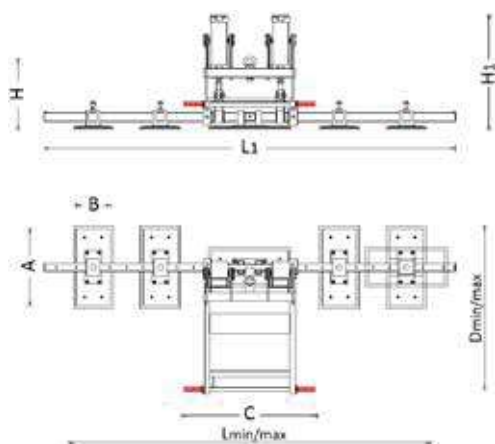

Piani cucina IN LINEA / Versione RIBASSATA

Portata da 625 a 1000 Kg / Ribaltamento PNEUMATICO da 0° a 90°

Kitchen top IN LINE / LOW version

Capacity from 625 to 1000 Kg / PNEUMATIC tilt from 0° to 90°

MODELLO MODEL	PORTATA (KG) CAPACITY	PIASTRE PLATES	A mm	B mm	A1 mm	B1 mm	C mm	D min mm	D max mm	L1 mm	L min mm	L max mm	H mm	H1 mm
VAM 5PN/625 KTL LOW	625	5	450	200	450	200	780	830	955	2400	1670	2740	415	670
VAM 5PN/625 KTL LOW	625	5	550	150	550	150	780	805	995	2400	1402	2820	415	670
VAM 5PN/1000 KTL LOW	1000	5	450	300	450	300	780	915	990	2400	2040	2755	420	715

VBK PN

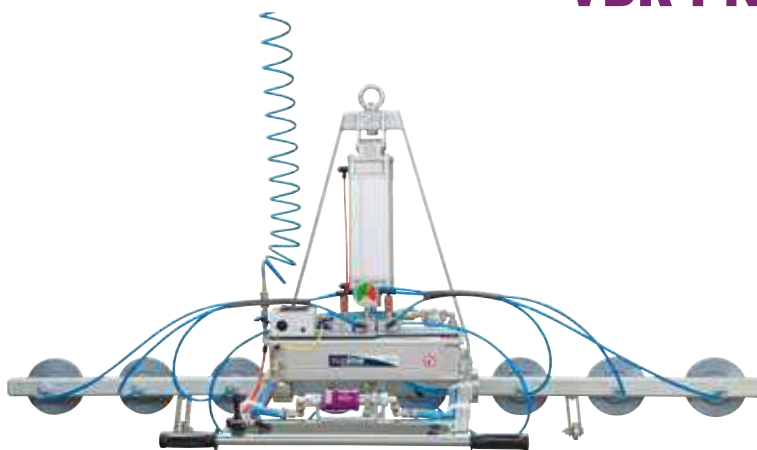
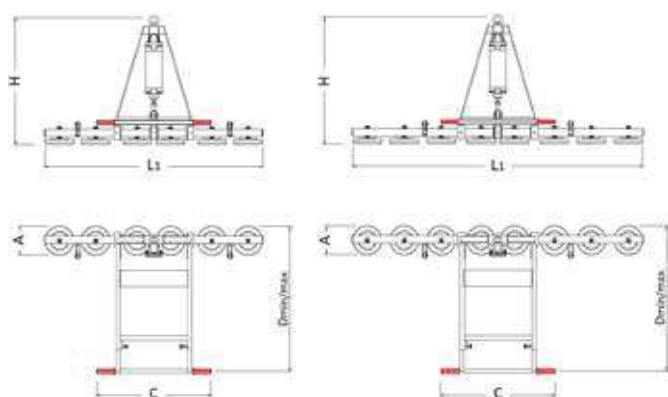

Piastre in ALLUMINIO e disposte IN LINEA

Portata da 160 a 500 Kg / Ribaltamento PNEUMATICO da 0° a 90°

ALUMINIUM suction plates placed IN LINE

Capacity from 160 to 500 Kg / PNEUMATIC tilt from 0° to 90°

MODELLO MODEL	PORTATA (KG) CAPACITY	PIASTRE PLATES	A mm	C mm	D min mm	D max mm	L1 mm	H mm
VBK 6PN/160	160	6	160	790	870	1400	1500	875
VBK 8PN/250	250	8	160	790	870	1400	2000	875
VBK 6PN/350	350	6	200	790	890	1420	1500	875
VBK 8PN/500	500	8	200	790	890	1420	2000	875

SPECIAL SOLUTIONS

EVOLUTION

Nuovo sistema EVOLUTION.

Portata 625 Kg

Ribaltamento PNEUMATICO da 0° a 90°

New EVOLUTION system.

Capacity 625 Kg

PNEUMATIC tilt from 0° to 90°

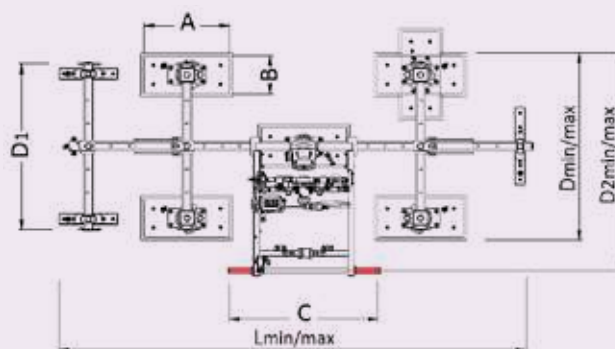
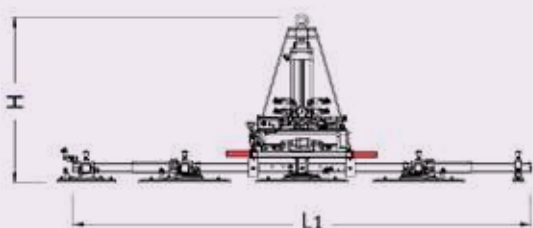
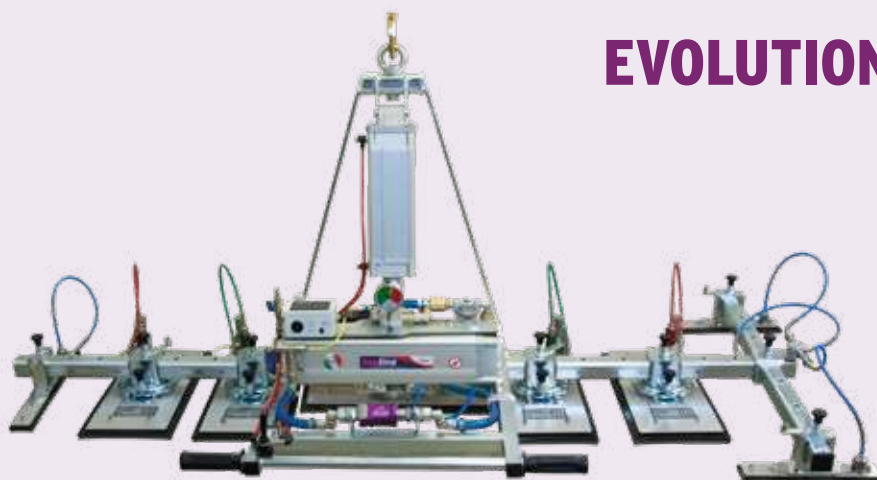

MODELLO MODEL	PORTATA (KG) CAPACITY	PIASTRE PLATES	A mm	B mm	C mm	D1 mm	D min mm	D max mm	D2 min mm	D2 max mm	L1 mm	L min mm	L max mm	H mm
VAM 5PN/625 EVO	625	5	450	200	780	870	470	1230	885	1265	2400	900**	2310	865

**CON PIASTRE IN VERTICALE E FORO PIÙ ESTERNO DELLO SBRACCIO / WITH PLATES IN VERTICAL AND EXTERNAL HOLE OF THE BAR

- Nuovo impianto aria brevettato interno alla struttura
- Valvole a corsoio in alluminio per ogni piastra
- Visualizzatore ottico di piastre in presa
- Supporti girevoli multiposizione
- Kit piastrelle SALVA PIANO CUCINA
- Economizzatore aria
- *New patented inside-the-structure air system*
- *Aluminium slider valves for every suction plate*
- *Special vacuum reading device for suction plates*
- *Multi-position rotating supports*
- *SAVE KITCHEN TOP little plates kit*
- *Air economiser*

Sistema EVOLUTION disponibile anche con altri modelli di ventose.

EVOLUTION system also available with other models of lifters.

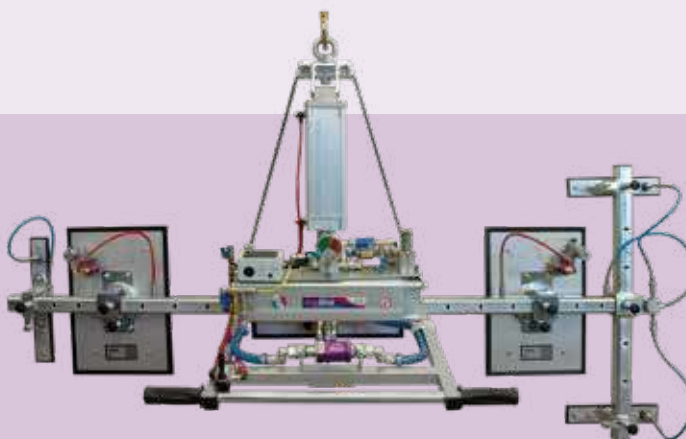

SPECIAL SOLUTIONS

RISANTRAV

Per materiali imperfetti.

Portata da 500 a 1000 Kg
Ribaltamento PNEUMATICO da 0° a 90°

For flawed materials.

Capacity from 500 to 1000 Kg
PNEUMATIC tilt from 0° to 90°

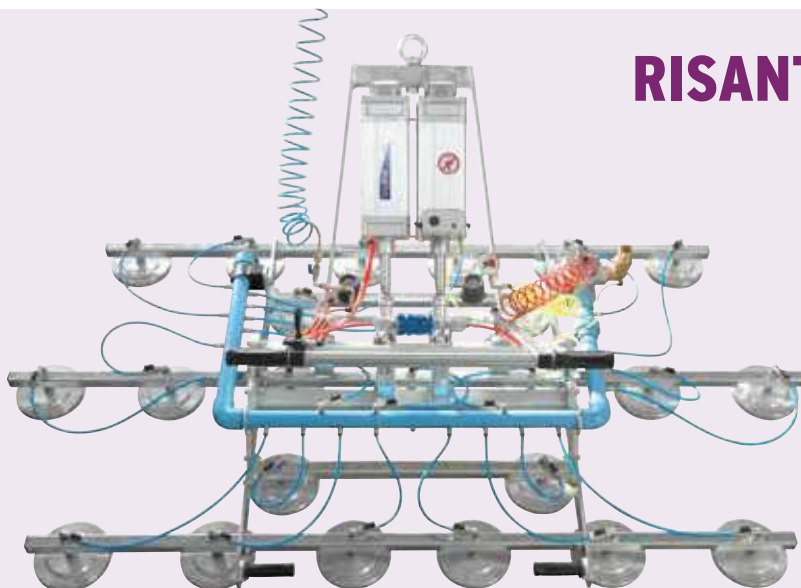

19PN/500

19PN/1000

23PN/1000

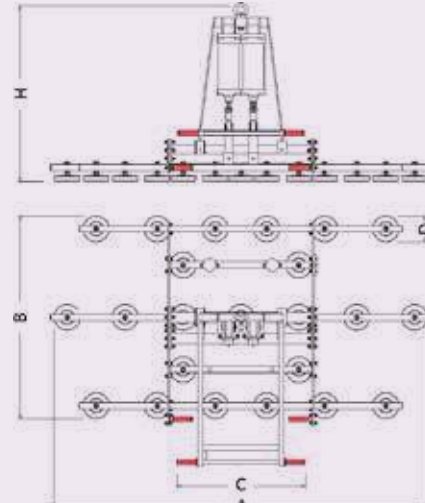
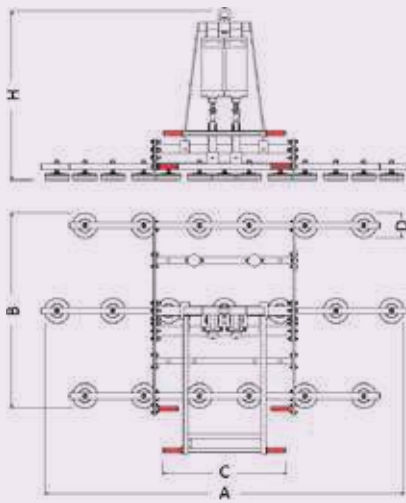
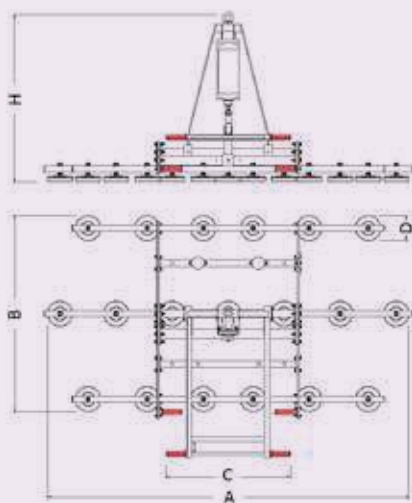

MODELLO MODEL	PORTATA (KG) CAPACITY	PIASTRE PLATES	D mm	A mm	B mm	C mm	H mm
RISANTRAV 19PN/500	500	19	160	2320	1260	790	1065
RISANTRAV 19PN/1000	1000	19	200	2360	1300	790	1090
RISANTRAV 23PN/500	500	23	160	2320	1260	790	1065
RISANTRAV 23PN/1000	1000	23	200	2360	1300	790	1090

Disponibili pompe elettriche del vuoto - per materiali porosi.

Electric vacuum pumps available - for porous materials.



SPECIAL SOLUTIONS

VAM 14PN GRES

Speciale per ceramica e superfici sottili.

Portata 350 Kg

Ribaltamento PNEUMATICO da 0° a 90°

Special for ceramic and thin surfaces.

Capacity 350 Kg

PNEUMATIC tilt from 0° to 90°

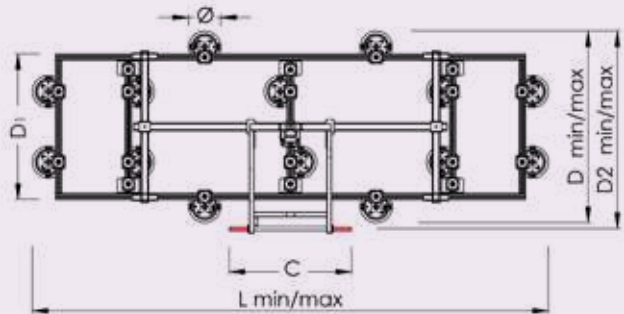
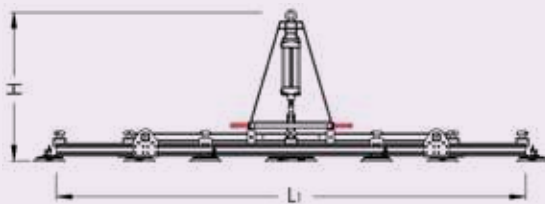
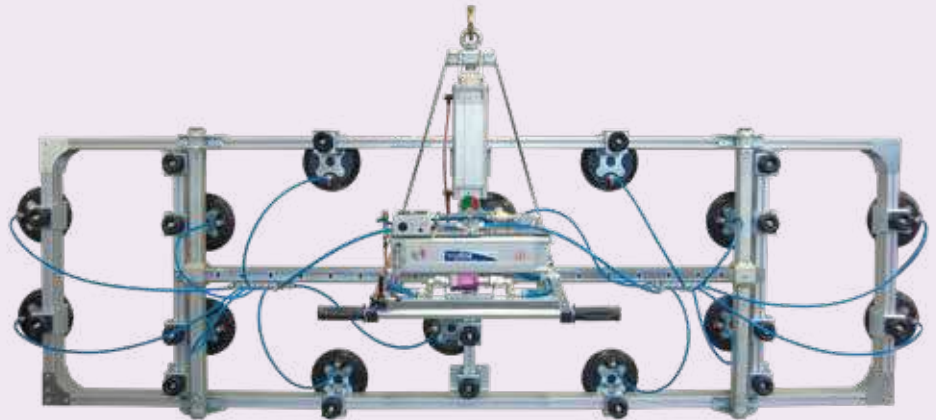

MODELLO MODEL	PORTATA (KG) CAPACITY	PIASTRE PLATES	∅ mm	C mm	D1 mm	D min mm	D max mm	D2 min mm	D2 max mm	L1 mm	L min mm	L max mm	H mm
VAM 14PN/350 GRES	350	14	450	780	964	970	1225	1135	1262	2400	3035	3295	945

- Struttura speciale in ALLUMINIO
- Traverse interne regolabili
- Piastre in ALLUMINIO VULCANIZZATO
- Supporti TOP PRIME

- *Special structure made of ALUMINIUM*
- *Internal adjustable crossbeams*
- *VULCANIZED ALUMINIUM suction plates*
- *TOP PRIME supports*



SPECIAL SOLUTIONS

VAM 4PN-G

Piani cucina VERSATILE.

Portata 500 Kg / Ribaltamento PNEUMATICO da 0° a 90°
ROTAZIONE MANUALE 0°-360° continui

Kitchen top VERSATILE.

Capacity 500 Kg / PNEUMATIC tilt from 0° to 90°
MANUAL continuous ROTATION 0°-360°

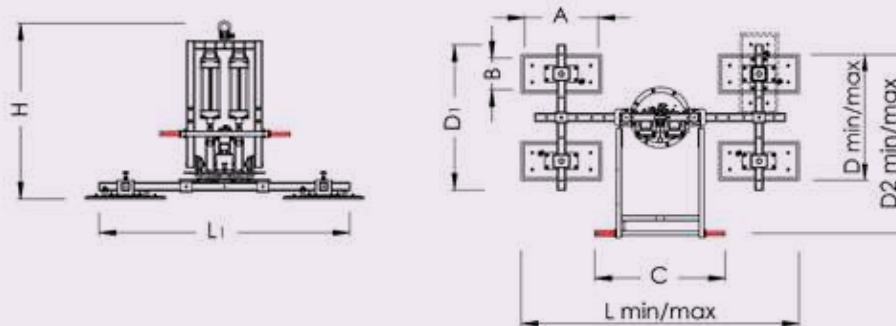

MODELLO MODEL	PORTATA (KG) CAPACITY	PIASTRE PLATES	A mm	B mm	C mm	D1 mm	D min mm	D max mm	D2 min mm	D2 max mm	L1 mm	L min mm	L max mm	H mm
VAM 4PN-G/500	500	4	450	200	780	870	470	1230	925	1305	1500	900	1840	1045
VAM 4PN-G/500 KTV	500	4	450	200	780	870	470	1230	885	1265	2400	900	2310	1045

- Ribaltamento con fermo multiposizione
- Rotazione manuale tramite ralla

- Tilt with multi-position stop
- Manual rotation through slewing bearing

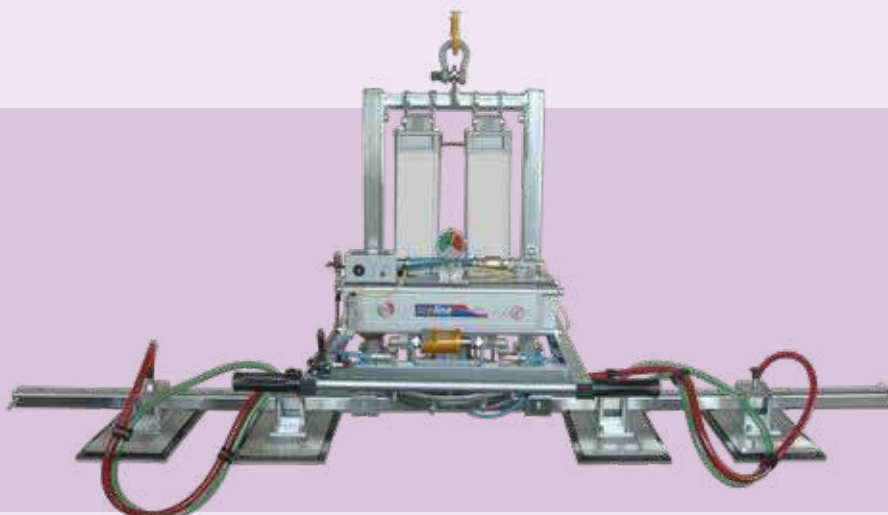

Rotazione 360° disponibile anche con altri modelli di ventose.

360° rotation also available with other models of lifters.

ACCESSORI / ACCESSORIES



ESPOSITORE CON RUOTE GIREVOLI
DISPLAY STAND WITH SWIVEL CASTERS



SOSTEGNO PORTA PULSANTIERA
PUSH BUTTON PENDANT HOLDER



SUPPORTI
GIREVOLI 0-90°
ROTATING
SUPPORTS 0-90°



KIT PIASTRINE SALVA PIANO CUCINA
SAVE KITCHEN TOP LITTLE PLATES KIT



SUPPORTI GIREVOLI
MULTIPOSIZIONE 0-180°
MULTI-POSITION ROTATING
SUPPORTS 0-180°



LIFTSTYLE s.r.l.

Via Enrico Fermi, 26
37026 Settimo di Pescantina
VERONA - Italia
P.iva 03482320235
tel. 0039 045 6450860
fax 0039 045 6450297
www.manzelli.net
e-mail:info@manzelli.it



**Jeronimo
& Morais**

FERRAMENTAS · PEDRA · AUTO

VISITE-NOS

Av. da Liberdade, nº 3
2715-097 Pêro Pinheiro
Portugal

+351 219 677 710
comercial@jeronimomorais.pt

